

HEIN-WERNER
AUTOMOTIVE®

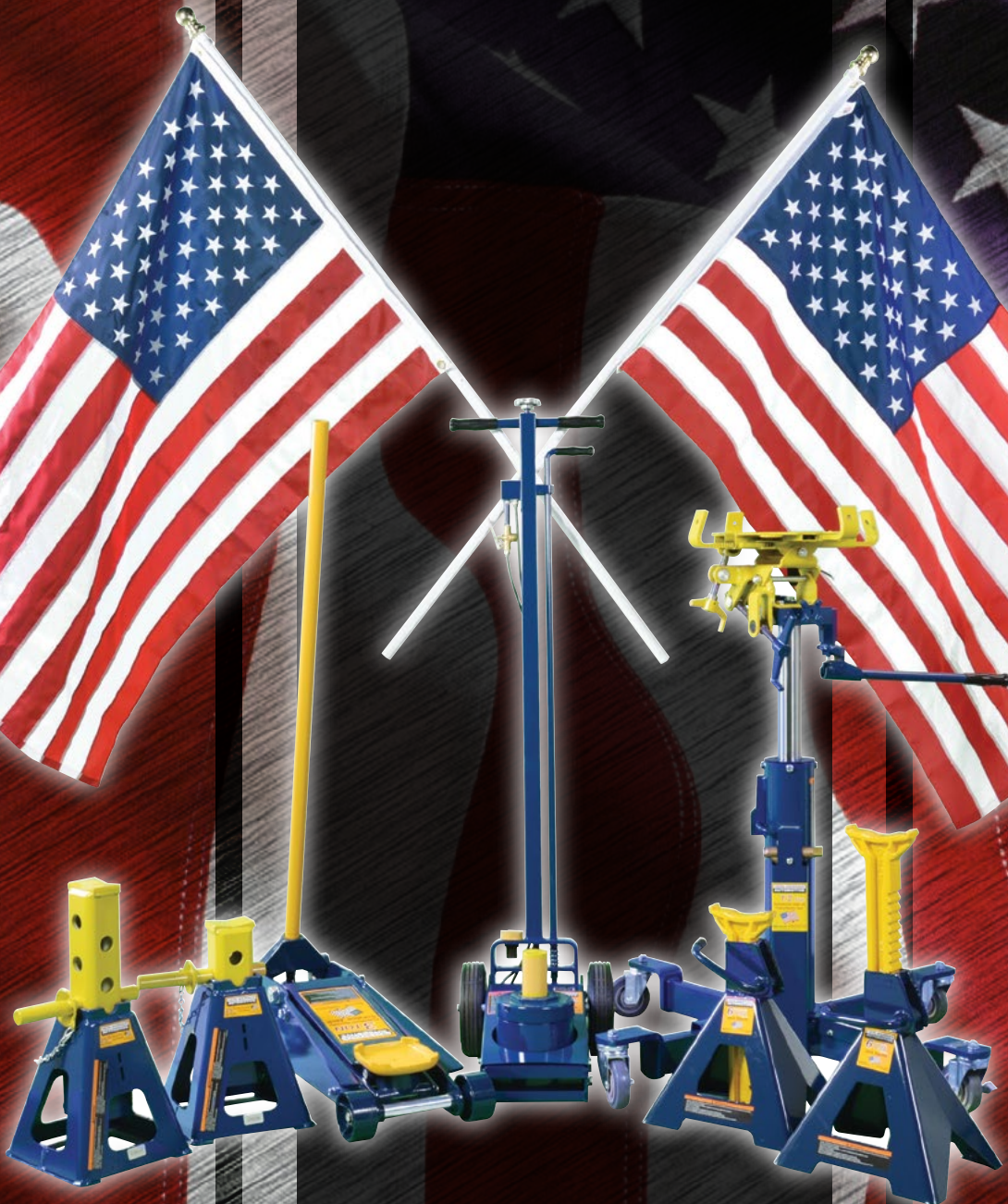

**Professional
Lift Equipment
Catalog**



Hein-Werner Lifting equipment is manufactured or assembled in the USA
All products come with a 2 year warranty.

3 Ton Service Jack	3
2 Ton Service Jack	3
4 Ton Service Jack	4
4 Ton Air/Manual Service Jack	4
10 Ton Manual Service Jack	5
10 Ton Air/Manual Service Jack	5
10 Ton High Reach Jack Stands	6
10 Ton Jack Stands	6
3 Ton Jack Stands	7
6 Ton Jack Stands	7
7 Ton Forklift Stands	7
25 Ton Forklift Stands	7
Bone Creepers	8
Saddle Extension Kit	9
20 Ton Truck Jack	9
20 Ton Truck Jack with Air	10
25 Ton Truck Jack	11
1 Ton Floor Style Transmission Jack	12
Transmission Jack Adaptor Kit	12
1/2 Ton Air/Hydraulic Telescopic Transmission Jack	13
10 Ton Air Jack	14
4 Ton Forklift Jack	15
3/4 Ton Wheel Dolly	16
1,250 Lbs. Engine Stand	17
3 Ton Engine Stand	18
3 Ton Engine Crane	19
2 Ton Foldable Engine Crane	20
Rotor Slings	21
Adjustable Slings	21
Load Leveler	21
2-1/2 Ton Air Operated End Lifts	22
10 Ton Air Operated End Lift	22
10 Ton Wheel Lift System	23
25 Ton Shop Presses	24
55 Ton Shop Presses	25
55 Ton Rolling Head Shop Presses	26
55 Ton Double Acting Shop Press	27
100 Ton Shop Presses	28
25 Ton Shop Press Kit	29
55 Ton Shop Press Kit	29
Jack Oil	29
Racing Chair	30
Warranty	31

HW93652 3 Ton Service Jack

HW93642 2 Ton Service Jack

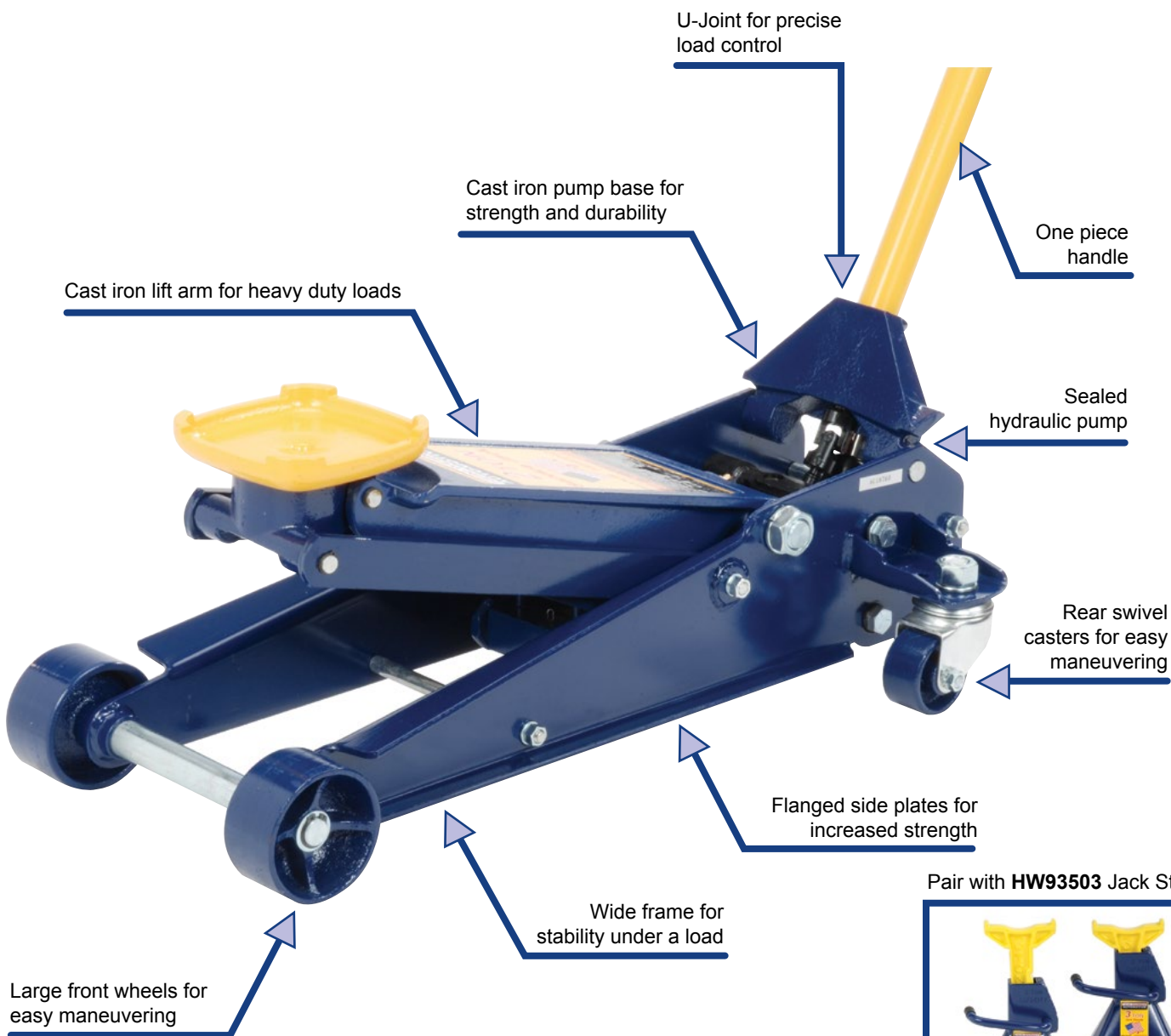

Pair with **HW93503** Jack Stands



*Assembled in the US with US and Global components

Model	Capacity	Minimum Height	Maximum Height	Power Raise	Saddle Diameter	Handle Length	Chassis Length	Chassis Height	Wheel to Wheel Width	G.W.
HW93642	2 Ton	4-1/2"	20-1/4"	15-3/4"	6-3/4"	50"	28-1/2"	6-3/4"	11-3/4"	90 Lbs.
HW93652	3 Ton	5"	23-1/2"	18-1/2"			31-1/2"	7-1/4"		107 Lbs.

HW93657 4 Ton Service Jack

Made in **USA**



T handle with release knob for ease of positioning and load control

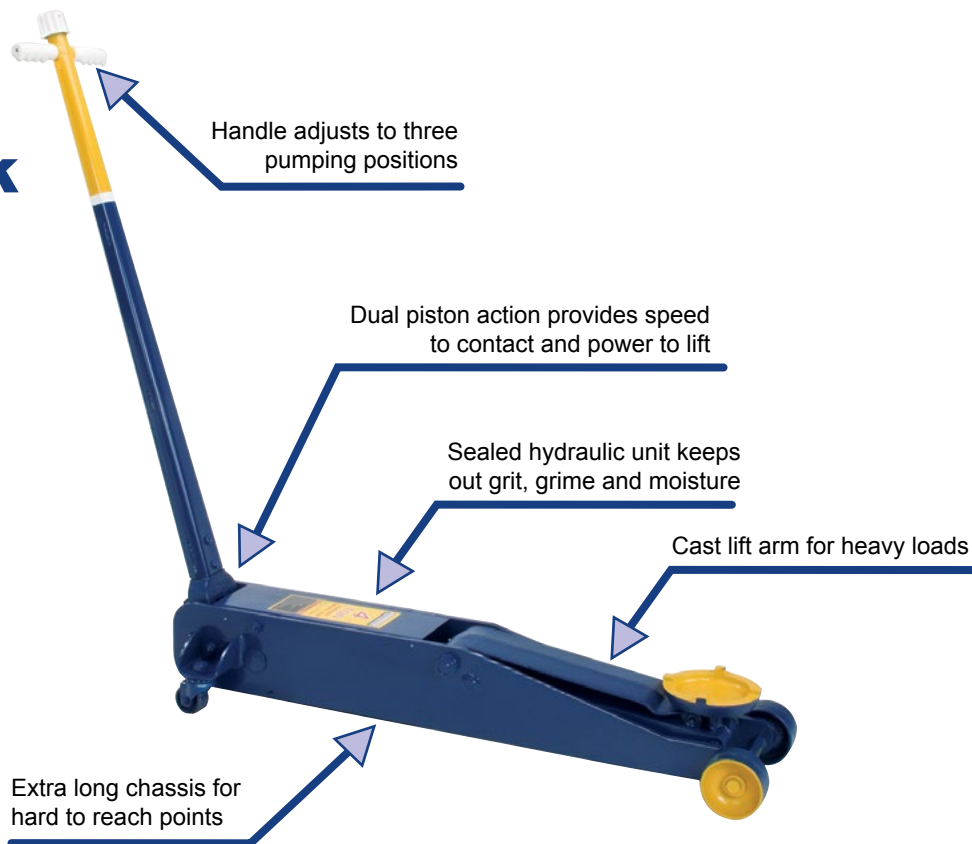

HW93667 4 Ton Air/Manual Service Jack

Made in **USA**

Includes all the features of the HW93657 plus:

- Operates manually or with air

Pair with **HW93506** Jack Stands

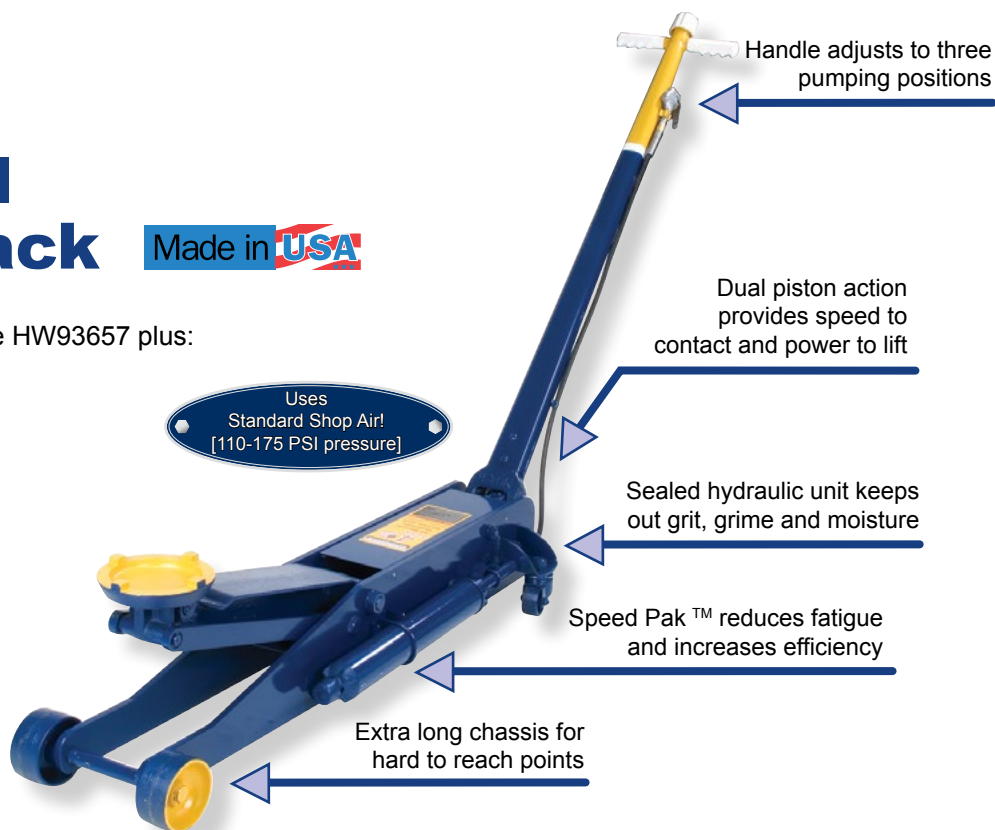

Model	Capacity	Minimum Height	Maximum Height	Power Raise	Saddle Diameter	Handle Length	Chassis Length	Chassis Height	Wheel to Wheel Width	Min. PSI For Rated Load	G.W.
HW93657	4 Ton	5"	25-3/4"	20-3/4"	7"	51"	49"	8"	15"	N/A	219 Lbs.
HW93667										140	233 Lbs.

HW93660 10 Ton Manual Service Jack

Made in USA

Pair with HW93512 Jack Stands



HW93662 10 Ton Air/Manual Service Jack

Includes all the features of the HW93660 plus:
Operates manually or with air
Speed Pak™ reduces lift time

Uses
Standard Shop Air!
[110-175 PSI pressure]

Made in USA

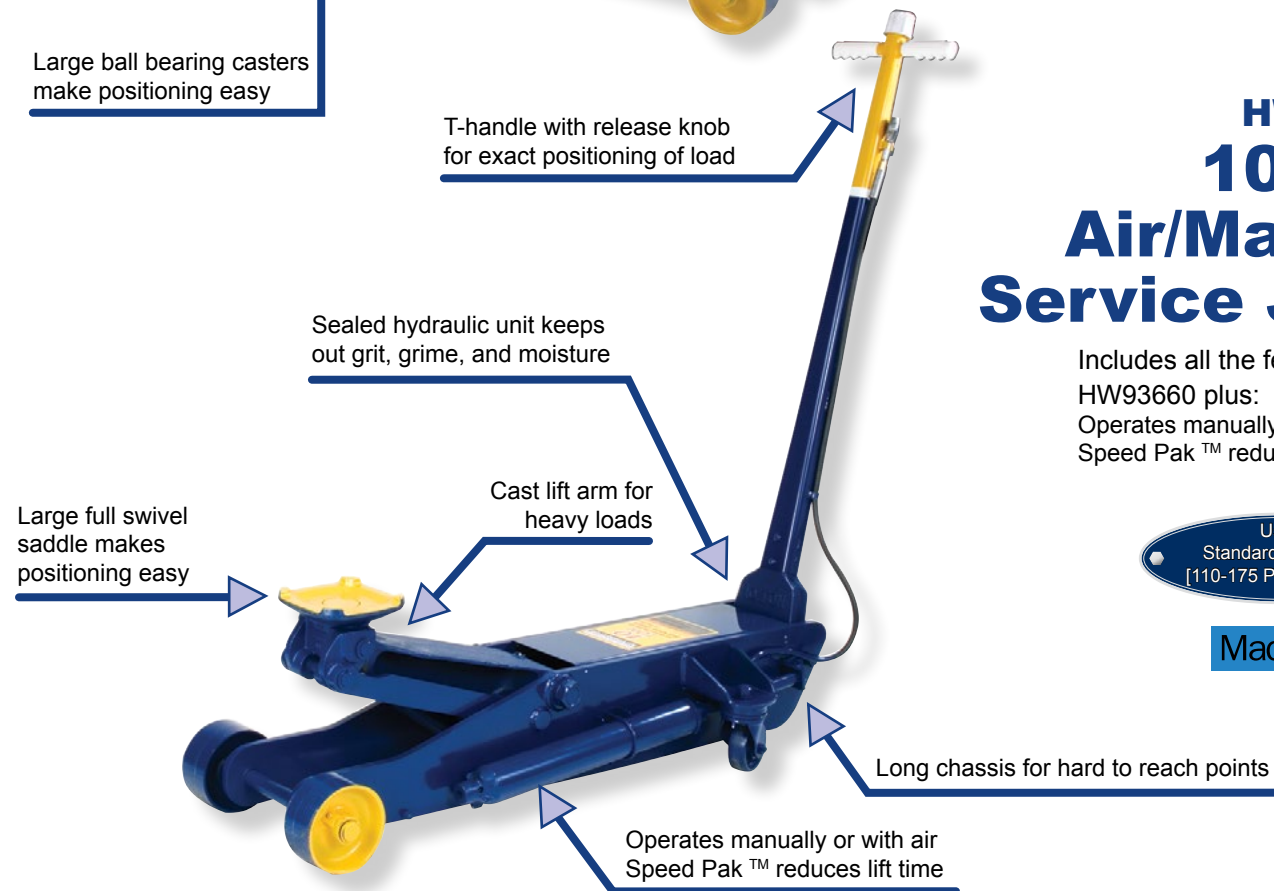
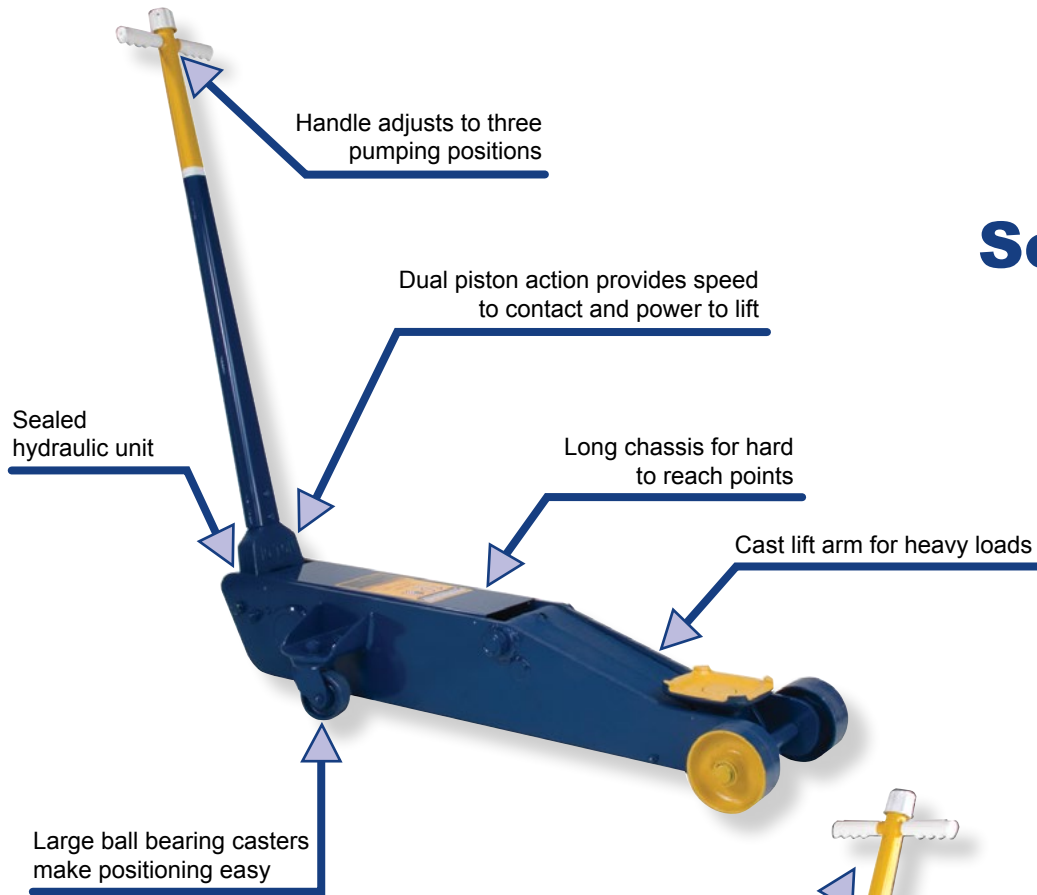

Model	Capacity	Minimum Height	Maximum Height	Power Raise	Saddle Diameter	Handle Length	Chassis Length	Chassis Height	Wheel to Wheel Width	Min. PSI For Rated Load	G.W.
HW93660	10 Ton	6-3/4"	25-1/2"	18-3/4"	8-1/2"	56"	53-1/2"	9-1/2"	20-1/2"	N/A	420 Lbs.
HW93662										140	435 Lbs.

HW93511 10 Ton High Reach Jack Stands

Made in  USA

Integrated wheels
for easy positioning

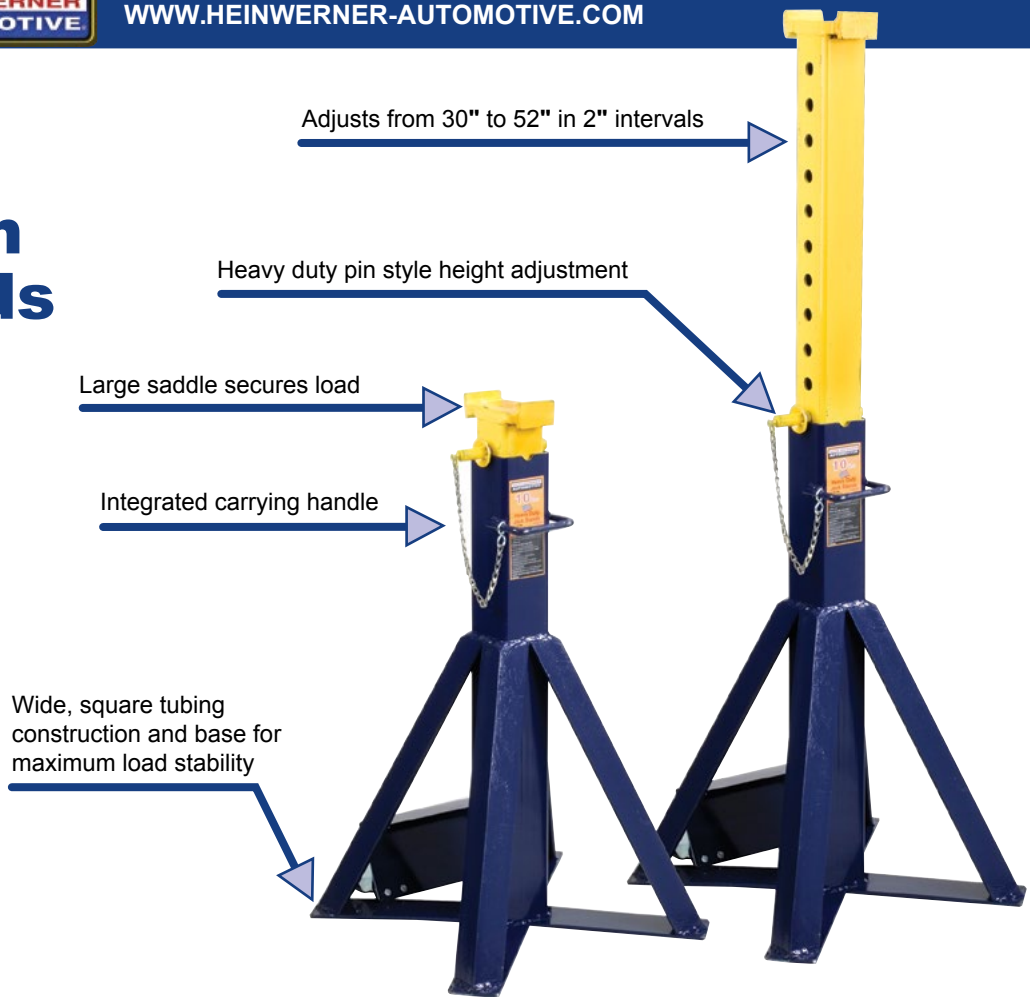

HW93512 10 Ton Jack Stands

Made in  USA

Wide, square tubing construction and
base for maximum load stability



Model	Capacity (per pair)	Minimum Height	Maximum Height	Height Intervals	Base Size	Saddle Size	G.W. (pair)
HW93511	10 Ton	30"	52"	2"	19"x19"	3"x 5-3/4"	144 Lbs.
HW93512		19-1/2"	31-1/2"		16"x16"		88 Lbs.

HW93503 3 Ton Jack Stands

HW93506 6 Ton Jack Stands



*Assembled in the US with US and Global components

Model	Capacity (per pair)	Minimum Height	Maximum Height	Height Intervals	Base Size	Saddle Size	G.W. (pair)
HW93503	3 Ton	12-1/8"	19"	5/8"	7-1/2" x 9"	1" x 4-1/2"	26 Lbs.
HW93506	6 Ton	16-1/4"	25-3/4"		10-1/2" x 13"	1" x 5"	45 Lbs.

HW93524A 7 Ton Forklift Stands

Made in USA

HW93526F 25 Ton Forklift Stands

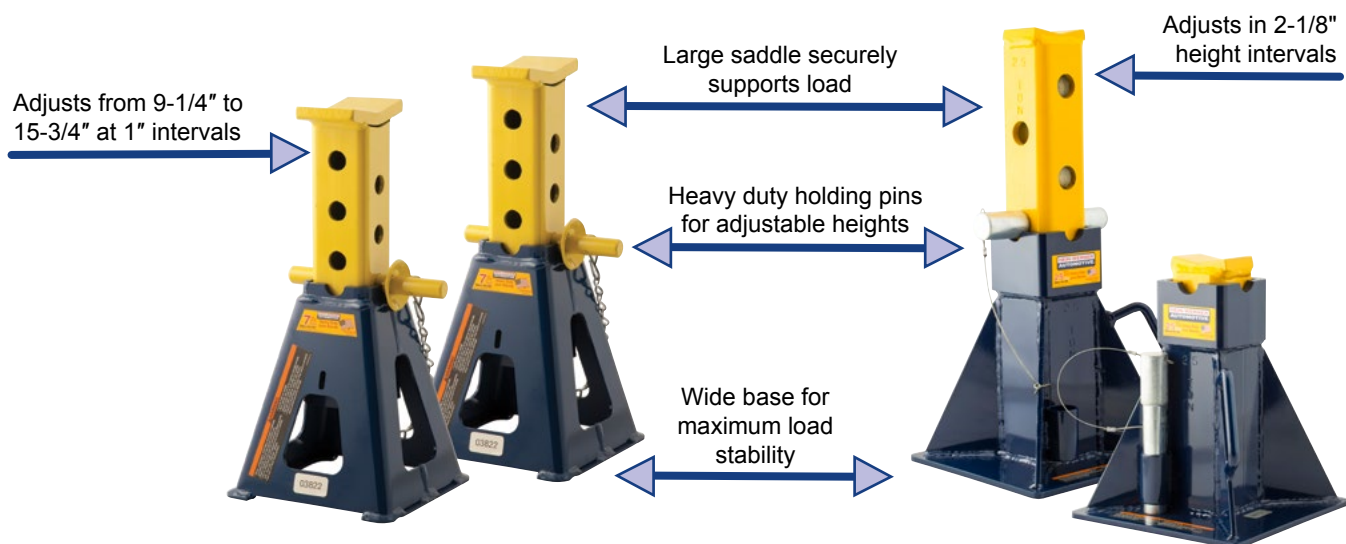

Model	Capacity (per pair)	Minimum Height	Maximum Height	Height Intervals	Base Size	Saddle Size	G.W. (pair)
HW93524A	7 Ton	9-1/2"	15-3/4"	1"	9-1/4" x 9-1/4"	2-1/2" x 4-1/2"	36 Lbs.
HW93526F	25 Ton	12-3/8"	20-3/8"	2-1/8"	9-7/8" x 9-7/8"	3" x 2-1/4"	89 Lbs.

Hein-Werner Bone Creepers

Made in **USA**

The Tailbone™ HW5031

The Tailbone Rough Rider™

- 350 Lbs. Capacity Creeper Seat
- 5" tread wheels
- 1 Year Warranty on Body
- Lifetime Warranty on Wheels

The Bone™ HW6031

- 300 Lbs. Capacity Creeper
- 5" tread wheels
- 1.25" Clearance
- 1 Year Warranty on Body
- Lifetime Warranty on Wheels



The Rough Rider™ HW7031

- 400 Lbs. Capacity Creeper
- 5.28" multi-terrain tread wheels
- 3" Clearance
- 1 Year Warranty on Body
- Lifetime Warranty on Wheels

The Bone-ster™ HW4031

- 400 Lbs. Capacity Creeper
- 3" tread wheels
- 1 Year Warranty on Body
- Lifetime Warranty on Wheels

Model	Description	Capacity	Dimensions (L x H x W)	Color	Item Weight
HW4031	Hein-Werner - The Bone-ster™ Mechanics Seat	400 Lbs.	43" x 5.25" x 24"	Blue	13 Lbs.
HW5031	Hein-Werner The Tail Bone™ Mechanics Seat	350 Lbs.	28" x 24" x 32"	Blue	15.5 Lbs.
HW5131	Hein-Werner The Tail Bone™ Rough Rider Mechanics Seat	350 Lbs.	28" x 24" x 32"	Blue	16.5 Lbs.
HW6031	Hein-Werner The Bone™ Mechanics Creeper	300 Lbs.	45.5" x 7.875" x 25.5	Blue	18 Lbs.
HW7031	Hein-Werner - The Rough Rider™ Mechanics Creeper	400 Lbs.	45.5" x 7.875" x 25.5	Blue	20 Lbs.

HW93733 20 Ton Truck Jack

Made in **USA**



Uses
Standard Shop Air!
[110-175 PSI pressure]

HW93265 Saddle Extension Kit

(Optional, for use only on HW93733)

Adds 1/2", 2-3/8", or 4"
to low pick-up heights

Optional adaptors provide
added height



Pressure relief valve
prevents overloading

Rapid two-speed air hydraulic
action quickly advances ram to load

Specially coated ram prevents
rust and extends jack life

Low height allows lifting
from axle or suspension

Large 8"
rubber wheels

Model	Capacity	Minimum Height	Maximum Height	Power Raise	Handle Length	Base Size	Extension Screw	Operating Pressure	G.W.
HW93733	20 Ton	9-1/2"	20"	5"	52-1/2"	20-1/2" x 13"	5-1/2"	110-140 PSI	97 Lbs.

HW93731 20 Ton Truck Jack

Made in  USA



Large rubber wheels
enhance mobility

Extension screw permits
pickup height adjustment

Speed Pak™
provides quick,
effortless lift

Model	Capacity	Minimum Height	Maximum Height	Power Raise	Handle Length	Base Size	Extension Screw	Operating Pressure	G.W.
HW93731	20 Ton	9-3/8"	17-5/8"	5-1/2"	39-1/2"	8-3/4" x 5-1/2"	2-3/4"	110-150 PSI	69 Lbs.

HW93735A 25 Ton Truck Jack

Made in 

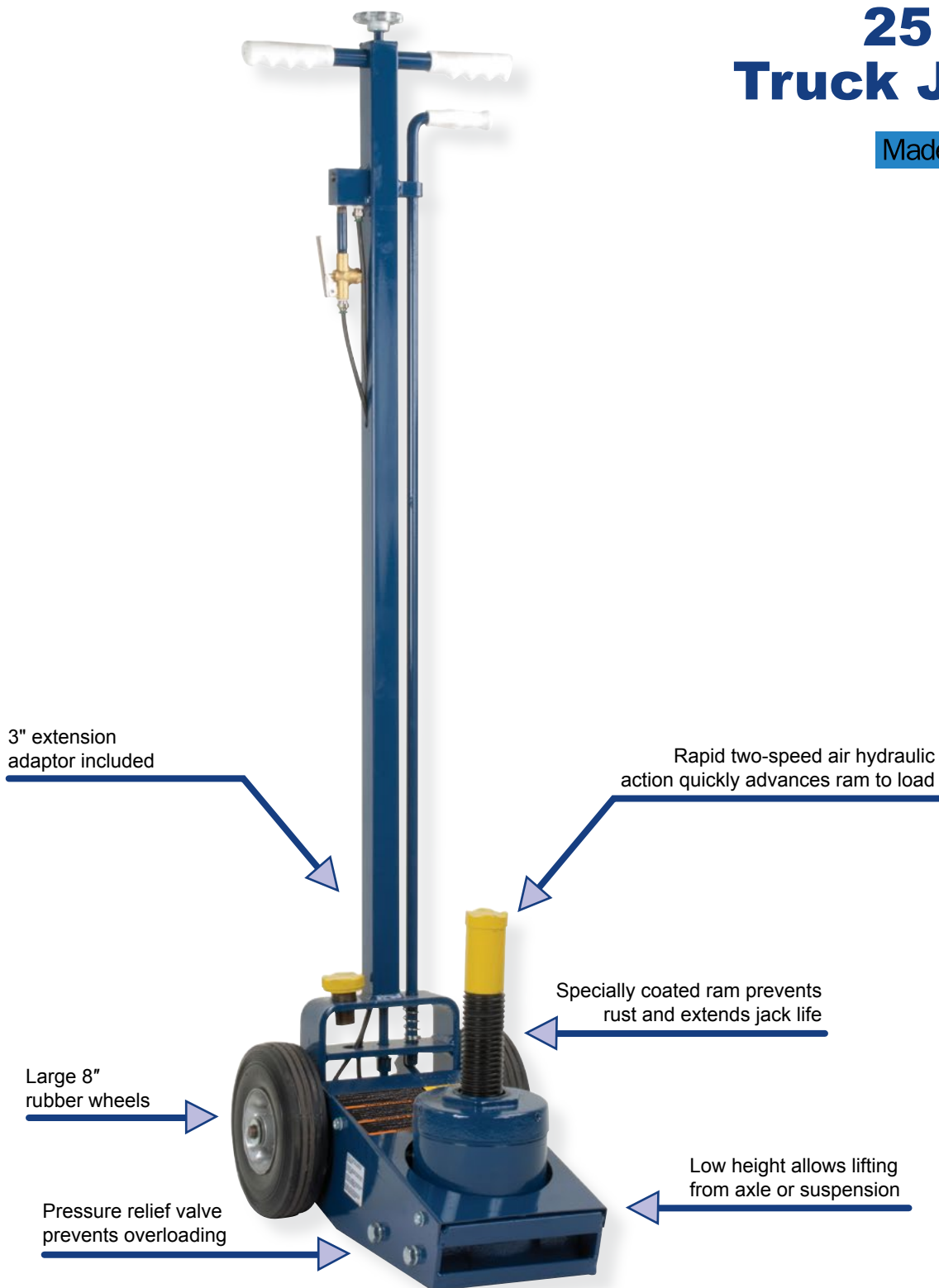

Model	Capacity	Minimum Height	Maximum Height w/adaptor	Power Raise	Handle Length	Base Size	Extension Screw	Operating Pressure	G.W.
HW93735A	25 Ton	8-1/4"	21-1/2"	5-1/8"	53"	20" x 14"	5-1/8"	110-200 PSI	118 Lbs.

HW93718 1 Ton Floor Style Transmission Jack

Made in **USA**

Designed for heavy duty transmissions, including:

- Fuller Roadrangers
- Spicer 50,60,5000,6000 and split torque (SST) series
- Mack T-2000 and Maxitorque series
- Allison AT, MT, and HT series
- Clark 280, 282, 285, CL455, and CL550
- Mercedes G3 and GV4 types
- Volvo S & R models
- Iveco 31, 35, 46, and 2828 models



HW93248 Adaptor Kit



- Allows user to remove and stabilize a Fuller Road Ranger truck transmission without first removing the PTO module, thus saving considerable labor time
- Heavy-duty steel construction
- For use with the HW93718 Hein-Werner Transmission Jack only

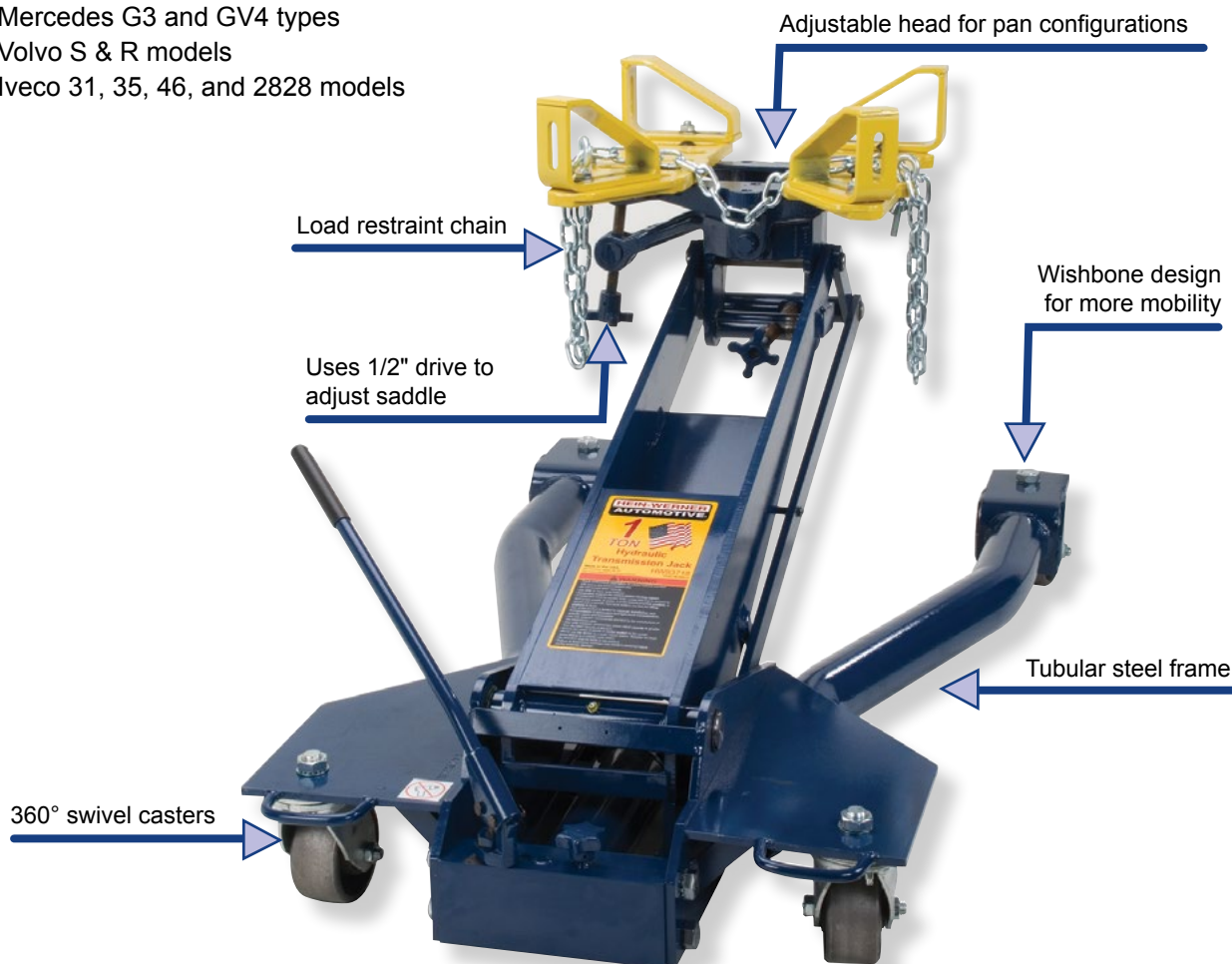

Model	Capacity	Minimum Height	Maximum Height	Chassis Length	Chassis Width	Forward Tilt	Rear Tilt	Sideways Tilt	G.W.
HW93718	1 Ton	10-1/4"	44-3/4"	47-1/2"	28-1/4"	44°	39°	13° L & R	310 Lbs.

HW93720 1/2 Ton Air/Hydraulic Telescopic Transmission Jack

Made in USA

Four ratchet brackets fit transmission pan flanges

Hefty nylon safety strap helps anchor transmission

Saddle adjustments are made easy with big, easy-to-grip crank handle

Air operated first stage

Hydraulically operated second stage

Wide caster base for smooth maneuverability

HW93721
Transmission Jack Multi Adaptor
For use on the HW93721

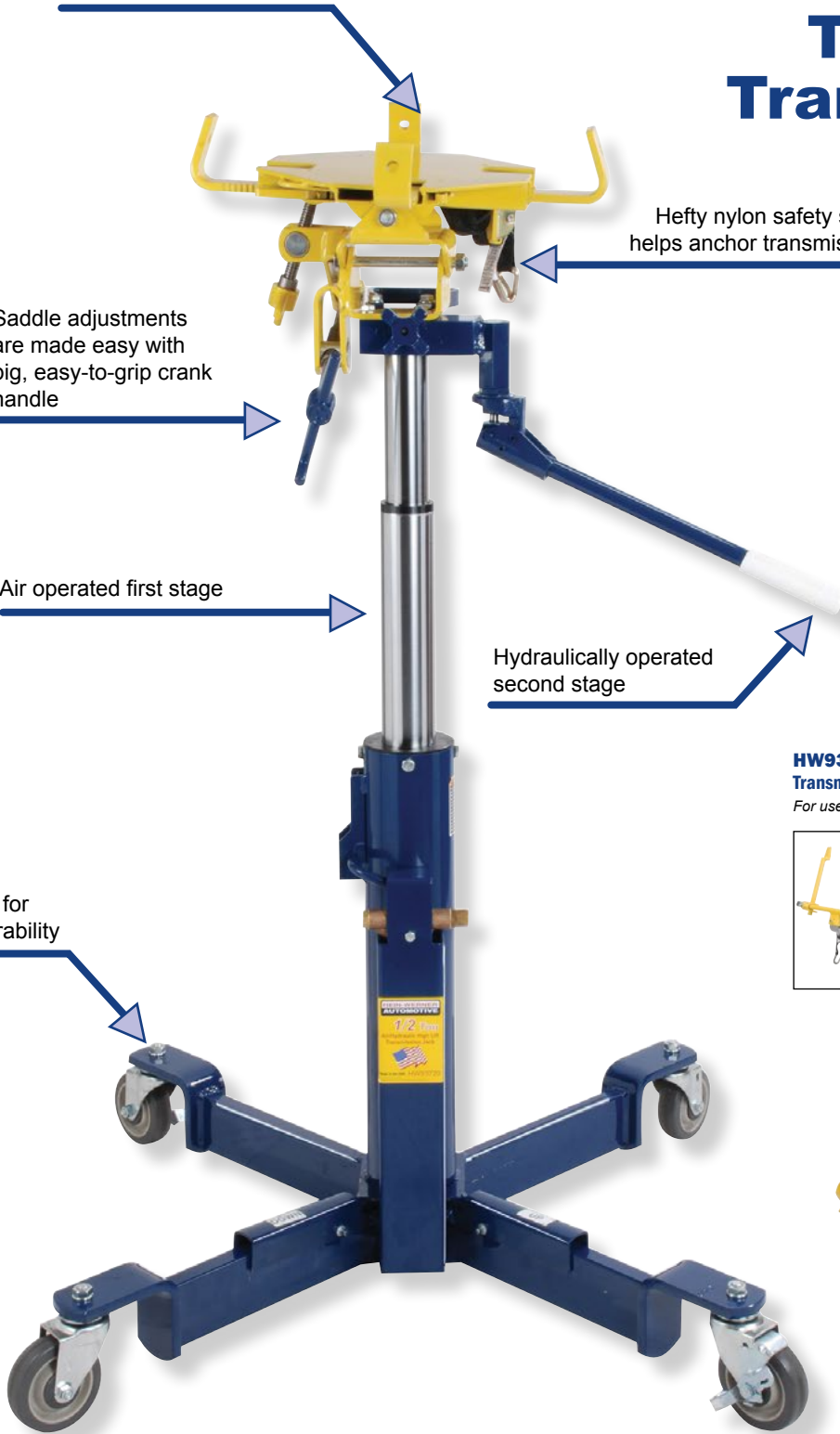
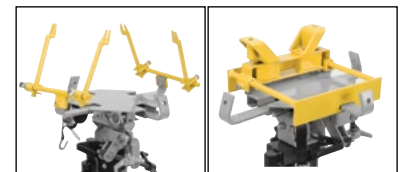

Model	Capacity	Minimum Height	Maximum Height	Lifting Head Height	Base Size	Forward Tilt	Rear Tilt	Sideways Tilt	G.W.
HW93720	1/2 Ton	34"	72"	11-3/8" x 11-3/8"	41-1/4" x 41-1/4"	35°	18°	11° L & R	117 Lbs.

HW93737A 10 Ton Air Jack

Made in  USA



Model	Capacity	Power Raise	Starting Height	Maximum Height	Base Diameter	Air Pressure for Rated Capacity	G.W.
HW93737A	10 Ton	11-1/2"	17-3/4" - 40"	51-1/2"	12"	200 PSI	165 Lbs.

HW93659 4 Ton Forklift Jack

Made in **USA**



Removable handle and compact size

Starting height of 2-1/2" and a maximum height of 16-3/4" provides a wide range of use

Two-position lift pad for secure contact on a variety of surfaces

Lift pads adjust with load plane as jack is raised and lowered

Model	Capacity	Minimum Height	Maximum Height	Power Raise	Handle Length	Base Size	G. W.
HW93659	4 Ton	2-1/2"	16-3/4"	14-1/4"	29"	8" x 26-1/2"	73 Lbs.

HW93766 3/4 Ton Wheel Dolly

Made in  USA

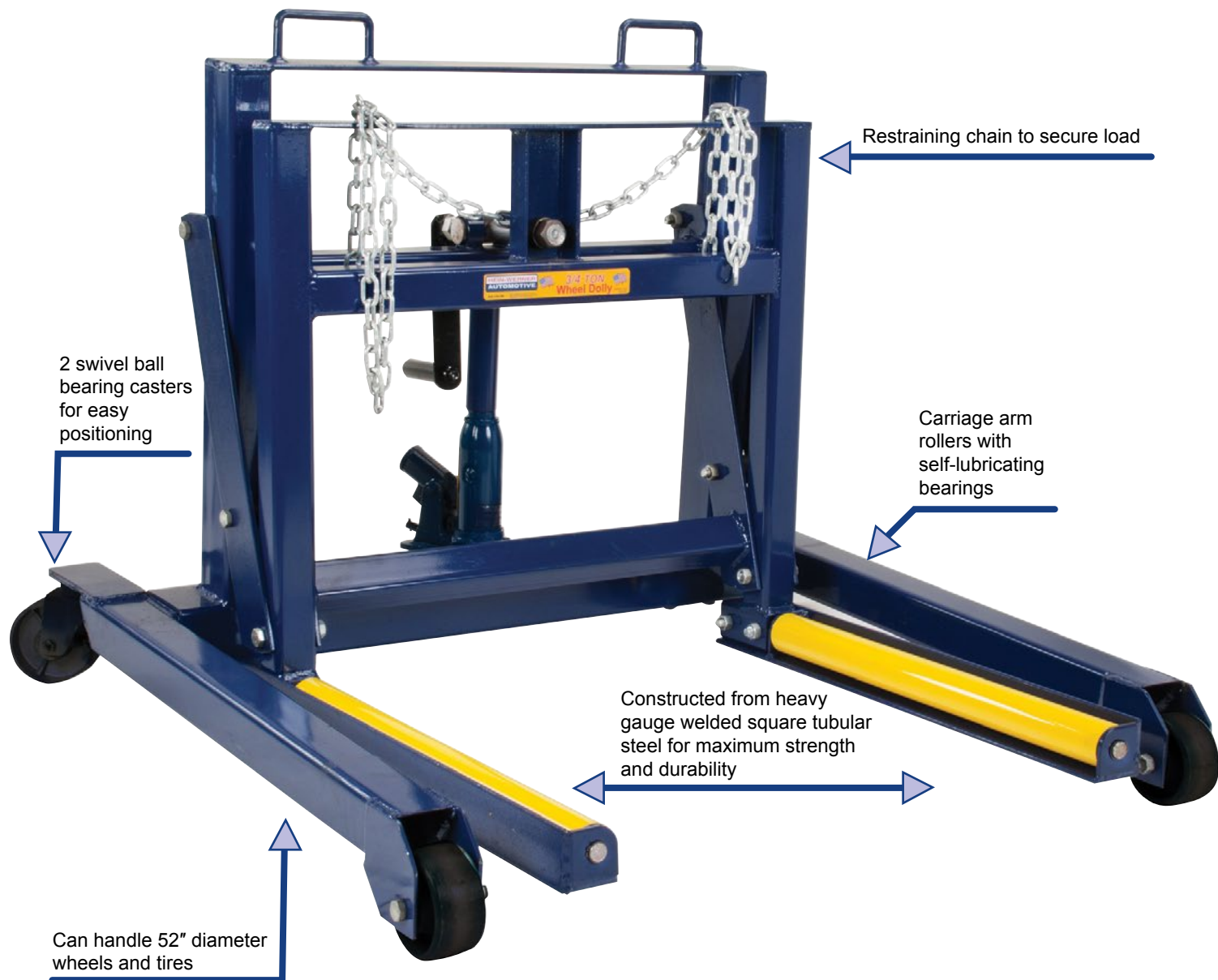

Model	Capacity	Lift Range	Lifting Arm Length	Lifting Arm Spread	Overall Length	Overall Width	Overall Height	G.W.
HW93766	3/4 Ton	4" - 9"	23"	26-1/2"	38-3/4"	39-1/2"	32"	118 Lbs.

HW93778
1,250 Lbs.
Engine
Stand

Made in **USA**



Model	Capacity	Base Size	Overall Height	Head Plate	Head Plate Thickness	Wheel Diameter	Caster Diameter	Handle Length	G.W.
HW93778	1,250 Lbs.	36" X 35"	34"	9-1/2" X 6"	3/4"	3"	3"	22-1/2"	79 Lbs.

HW93776 3 Ton Engine Stand

Made in  USA

Long handle provides easy engine rotation with 95 to 1 gear

Clearance in 360° rotation

Universal adaptor included for use with a wide variety of optional adaptors listed below

Floor lock keeps stand from moving during repairs

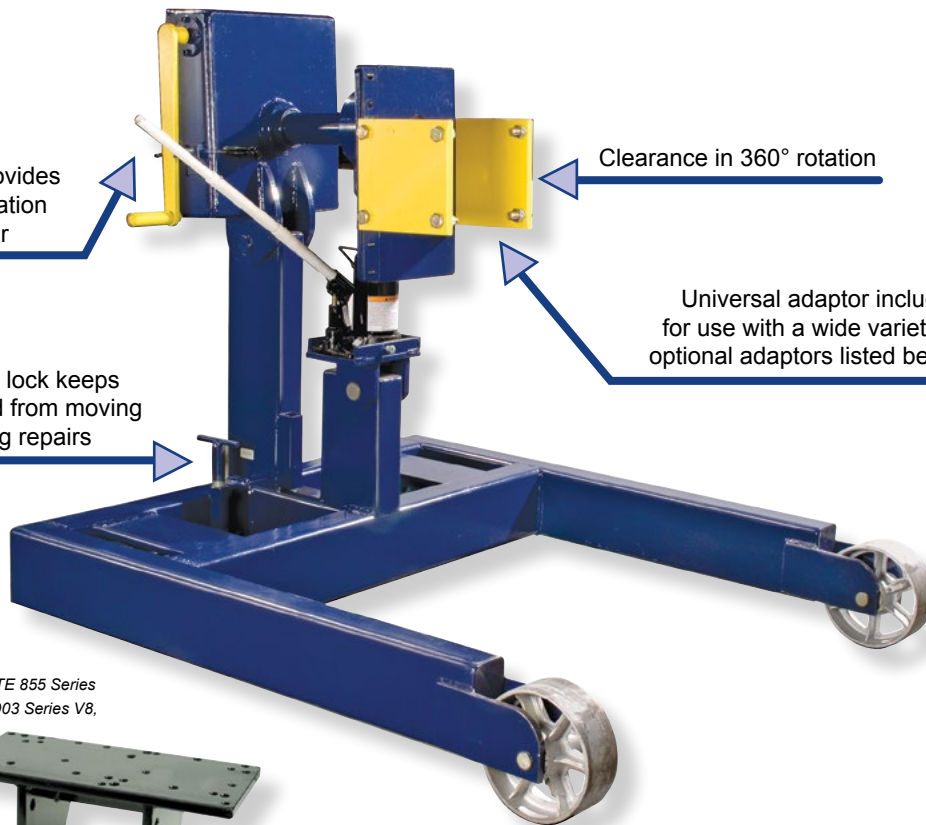

HW93776-1

Cummins Engine Stand Adaptor

For Cummins engines: all NH, NTC, & NTE 855 Series in-line 6 cyl., 378 Series V6, 504, 555 & 903 Series V8, KT 1150 Series in-line 6 Cyl. L10



HW93776-2

Detroit Engine Stand Adaptor

For Detroit engines: 53 Series in-line 6 Cyl., 6V & 8V also 71 series in-line 6 cyl., 6V, 8V & 12V also 92 series 6V & 8V also 8.2 liter V8.



HW93776-3

Mack Diesel Engine Stand Adaptor

For Mack engines: 672, 673, 675 & 711. Series in-line 6 cyl.



HW93776-4

International Diesel Engine Stand Adaptor

For International Harvester engines: DT-466 in-line 6 cyl. DV-550, MV-404, MV-446, V304, V435, V392, 4-152, 4-194, 4-196, 9.0 liter V8, 6.9L (Ford).



HW93776-5

Caterpillar Engine Stand Adaptor

For Caterpillar engines: 1673, 1674, 1693, 3306 & 3406 in-line 6 cyl. also 1100 & 3208 V8 and 3408 V8.



HW93776-6

Allison Transmission Adaptor

All Allison transmissions: AT 500, MT 600, MT 6 speed, VH, VS and V730



HW93776-7

Small Vehicle Adaptor

Small size vehicle and light truck engine 2,000 Lbs.. capacity.



Model	Capacity	Overall Dimensions			Wheel Diameters		Rotational clearance from MTG. Head to Ground	G.W.
		Height	Width	Length	Front	Rear		
HW93776	3 Ton	45-3/4"	46"	52"	8"	5-3/4"	37-1/2" to 43-1/4"	602 Lbs.

HW93806 3 Ton Engine Crane

Made in **USA**

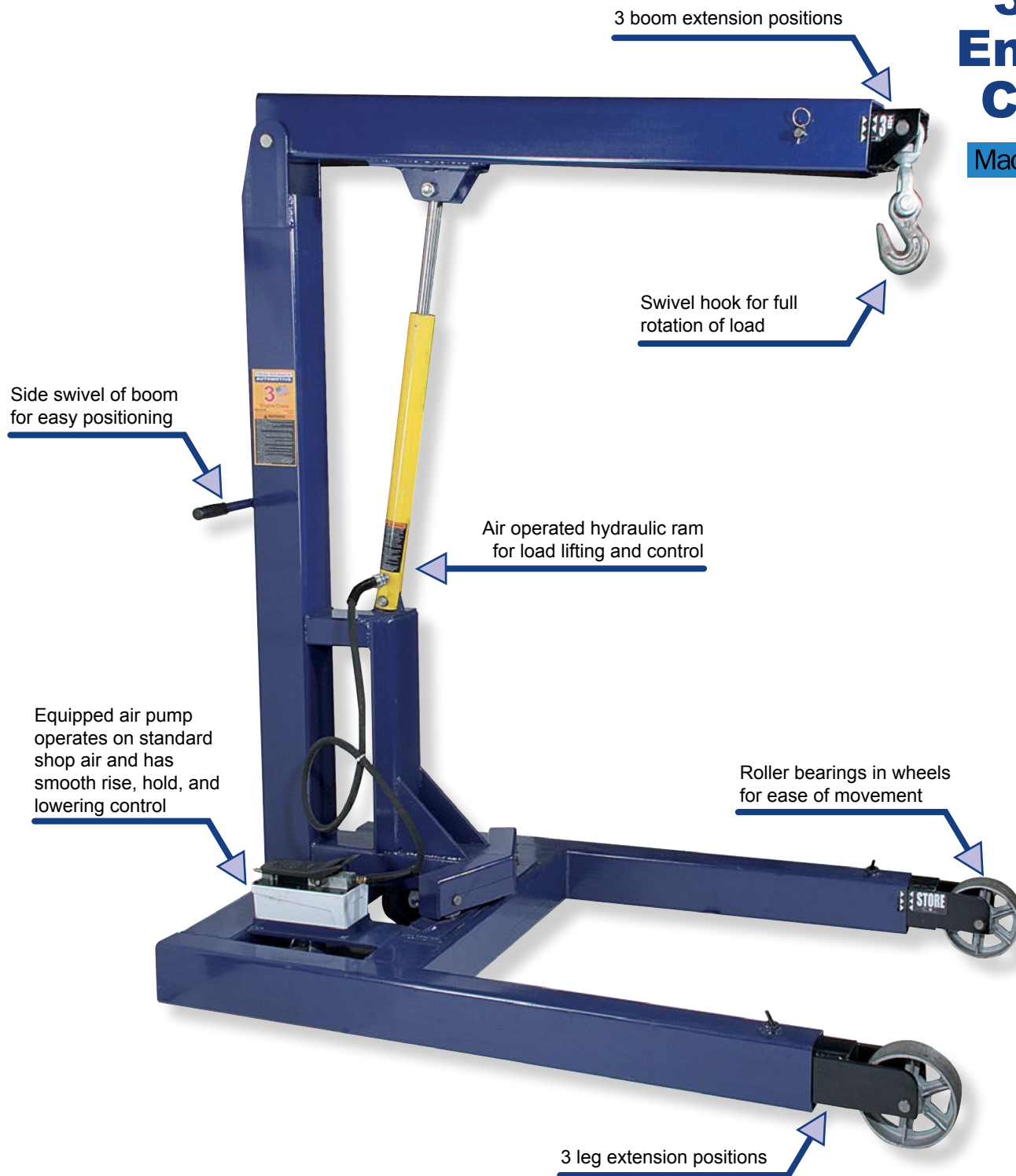

Model	Boom Capacity @ Length	Hook Height		Leg Extension	Overall Dimensions			Wheel Diameter		G.W.
		Min.	Max.		Height	Width	Length	Front	Rear	
HW93806	3 Ton	30-1/2"	120-1/2"	91-1/4"	87"	51"	75"	8"	6"	1,044 Lbs.
	2-1/2 Ton	18-1/2"	132-1/2"	106-3/4"						
	2 Ton	6-1/2"	144-1/2"	123"						

HW93809 2 Ton Foldable Engine Crane

Made in 



Model	Capacity (retracted)	Capacity (center)	Capacity (extended)	Max. Boom Height (retracted)	Max. Boom Height (extended)	Overall Boom Height (horizontal)	Boom Reach (retracted)	Boom Reach (extended)	Overall Length	Min. Throat Width
HW93809	4,400 Lbs.	3,800 Lbs.	3,300 Lbs.	119"	130"	84"	35-3/4"	50-3/4"	82"	22"

Model	Leg Length (inside)	Inside Leg Width (3 Positions)			Leg Height	Wheel Diameter	G.W.
		1	2	3			
HW93809	55"	22"	36"	50"	8-1/8"	6"	640 Lbs.

Rotor Slings

Made in USA

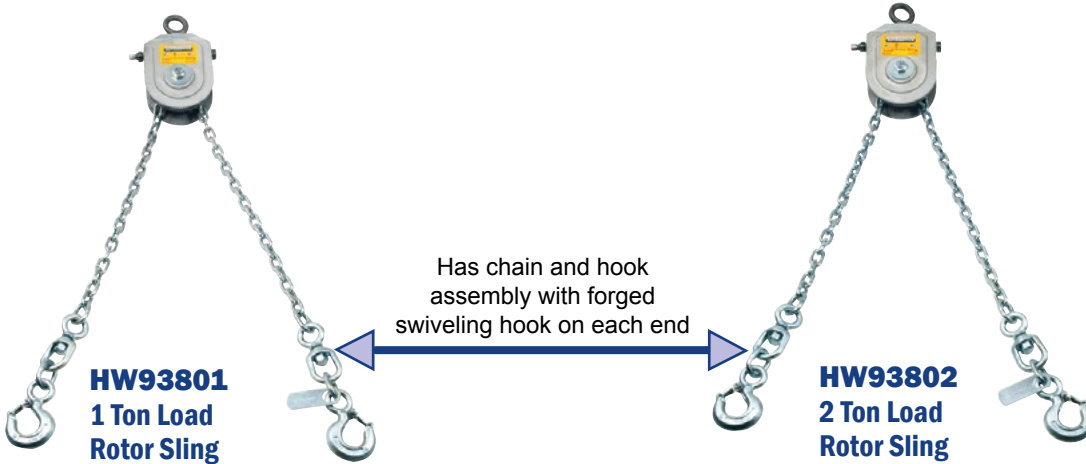

HW93801
1 Ton Load Rotor Sling

HW93802
2 Ton Load Rotor Sling

- Load Sling is intended for use with an engine crane or hoist
- Engines or other components can be tilted or leveled by turning sling's hex drive end with a common speed handle and socket

Model	Capacity	Hex Drive	Chain Length	Link Size	Weight
HW93801	1 Ton	5/8"	65"	5/16"	17 Lbs.
HW93802	2 Ton		100"		31 Lbs.

Adjustable Slings

Made in USA



HW93803
1 Ton Adjustable Load Sling

HW93804
2 Ton Adjustable Load Sling

- Designed for use with a crane or hoist to support large, bulky loads
- Chain length may be adjusted to compensate for off-center loads or for an alignment angle during assembly or disassembly

Model	Capacity	Chain Length	Link Size	Weight
HW93803	1 Ton	65"	7/32"	4.8 Lbs.
HW93804	2 Ton		5/16"	9.3 Lbs.

Adjustment nuts on both ends of the extension screw make tilting the load easy and accessible

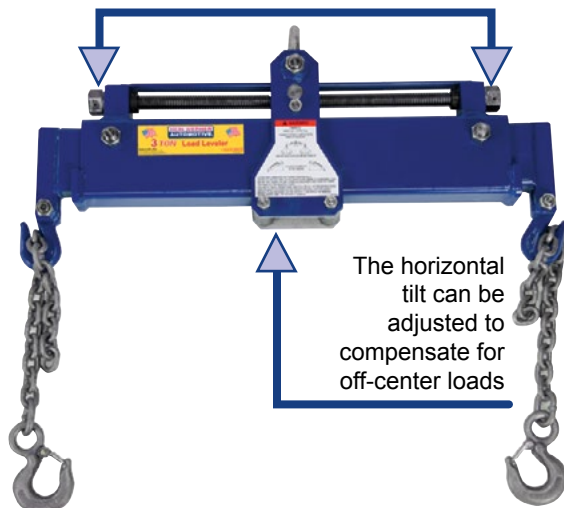

Extendable arms make this unit adjustable for the desired length needed

The horizontal tilt can be adjusted to compensate for off-center loads

HW93805
3 Ton Load Leveler

Load Leveler

Made in USA

- Designed to handle and position heavy components with use of an engine crane or hoist
- It can also be used to angle a component when necessary to install it

HW93696A & HW93696U 2-1/2 Ton Air Operated End Lift

U-Model
with Remote
Operation

Made in USA



Three-way heavy duty brass air valve provides precision control when lifting or lowering a vehicle

Safety latch design (in back) provides six different automatic safety lock positions to prevent unintentional lowering of load

HW93690 10 Ton Air Operated End Lift

Made in USA



Adjustable lifting arm can be extended to desired position

Two front swivel caster wheels and two 12" diameter semi-pneumatic rear tires provide easy maneuvering

Heavy duty wide base for stability and strength



Model	Capacity	Minimum Height	Maximum Height	Power Raise	Saddle Spread	Min. Air Pressure For Rated Load	Distance (Lifting to Front of Saddle)	G.W.
HW93690	10 Ton	18-1/2"	50-1/2"	28"	28" - 53"	200 PSI	17"	641 Lbs.
HW93696A	2-1/2 Ton	8"	35-3/8"	24-3/4"	23-1/4" - 41-1/4"		19"	210 Lbs.
HW93696U								214 Lbs.

AIR CONTROL UNIT

One control valve operates both units simultaneously



HW93693 10 Ton Wheel Lift System

Made in USA

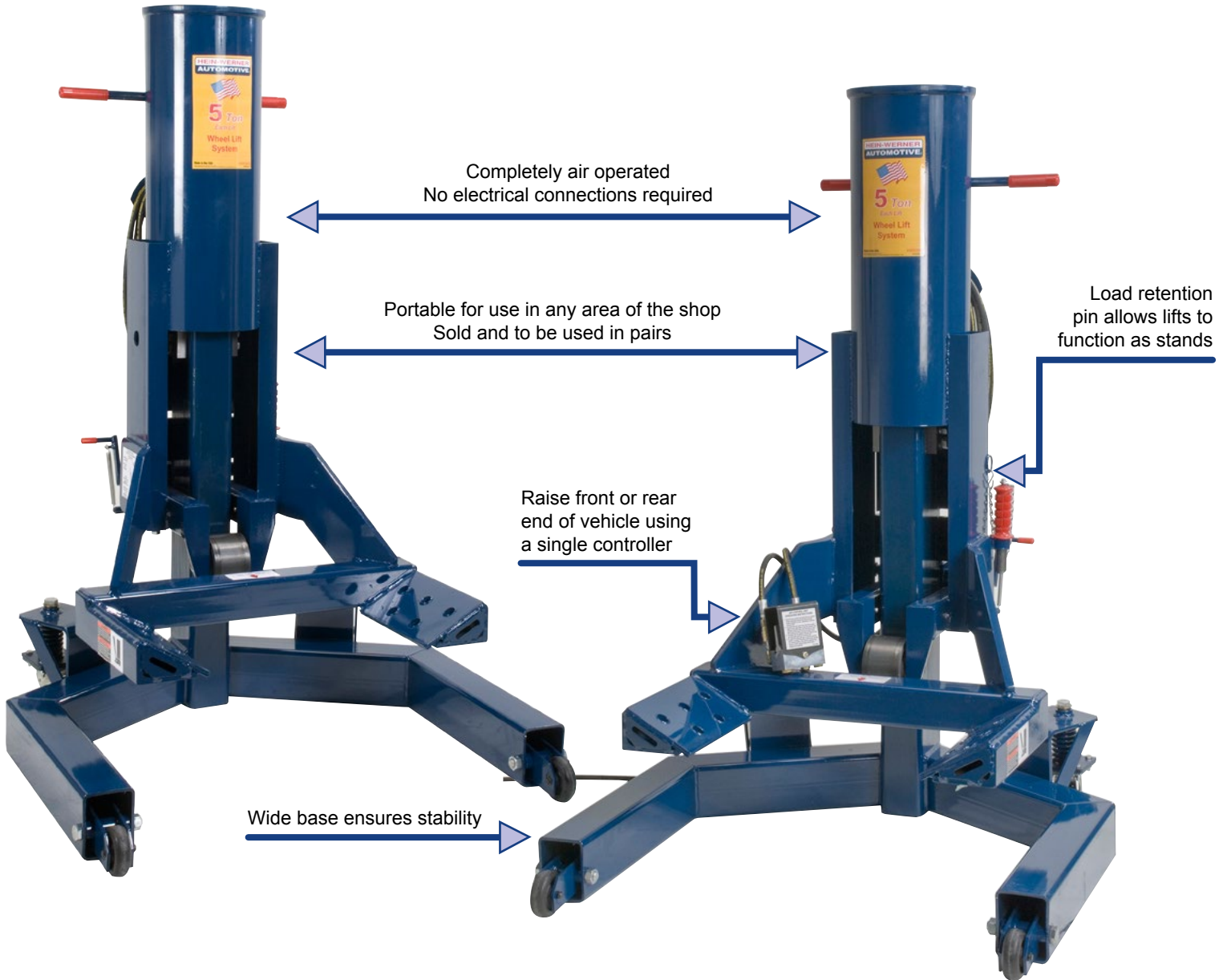

Model	Capacity	Minimum Height	Maximum Height	Power Raise	Min. Wheel Diameter	Max. Wheel Diameter	Frame Size (W x D X H)	Operating Pressure	G.W.
HW93693	10 Ton	Floor Level	24"	24"	19.5"	24.5"	41-9/16" X 44-1/4" X 53-1/4"	160 PSI	1,234 Lbs.

HW93300 SERIES - MANUAL OR AIR 25 Ton Shop Press

- Frames made in the USA

Made in **USA**

- Excellent for bending, bonding, or straightening applications
- Ideal for the removal or installation of gears, universal joints, pulleys, wrist pins, and other press jobs
- Industrial grade hydraulics

Includes hand winch for easy bed adjustments

Multi-position bed for work height adjustment

Heavy steel welded construction

Industrial grade rams and hydraulic pumps

4" pressure gauge standard (on pump)

Optional Shop Press Guard HW93325

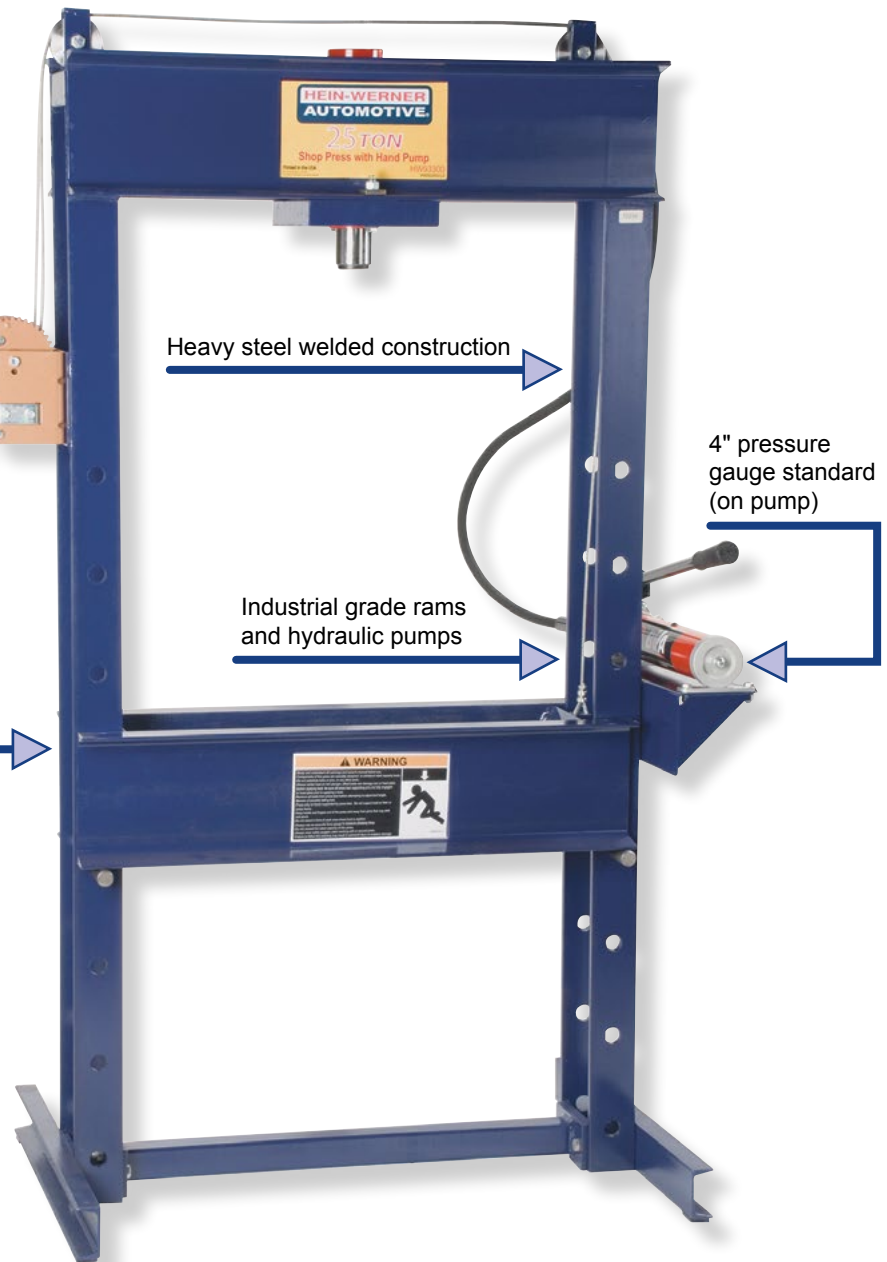

Model	Capacity	Stroke	Pump Type	Press Size (H x W x L)	Interior Width	Bed Depth	Bed Position	Channel Width	Working Height	G.W.
HW93300	25 Ton	6"	Manual	71 x 44 x 30	29-3/4"	11-1/2"	8	6-3/4"	5-1/2" ~ 47-1/2"	484 Lbs.
HW93301			Air							487 Lbs.
HW93305			Manual							510 Lbs.
HW93306			Electric							510 Lbs.

HW93400 SERIES - MANUAL, AIR OR ELECTRIC 55 Ton Shop Press

- Frames made in the USA

Made in USA

- Excellent for bending, bonding, or straightening applications
- Ideal for the removal or installation of gears, universal joints, pulleys, wrist pins, and other press jobs
- Industrial grade hydraulics

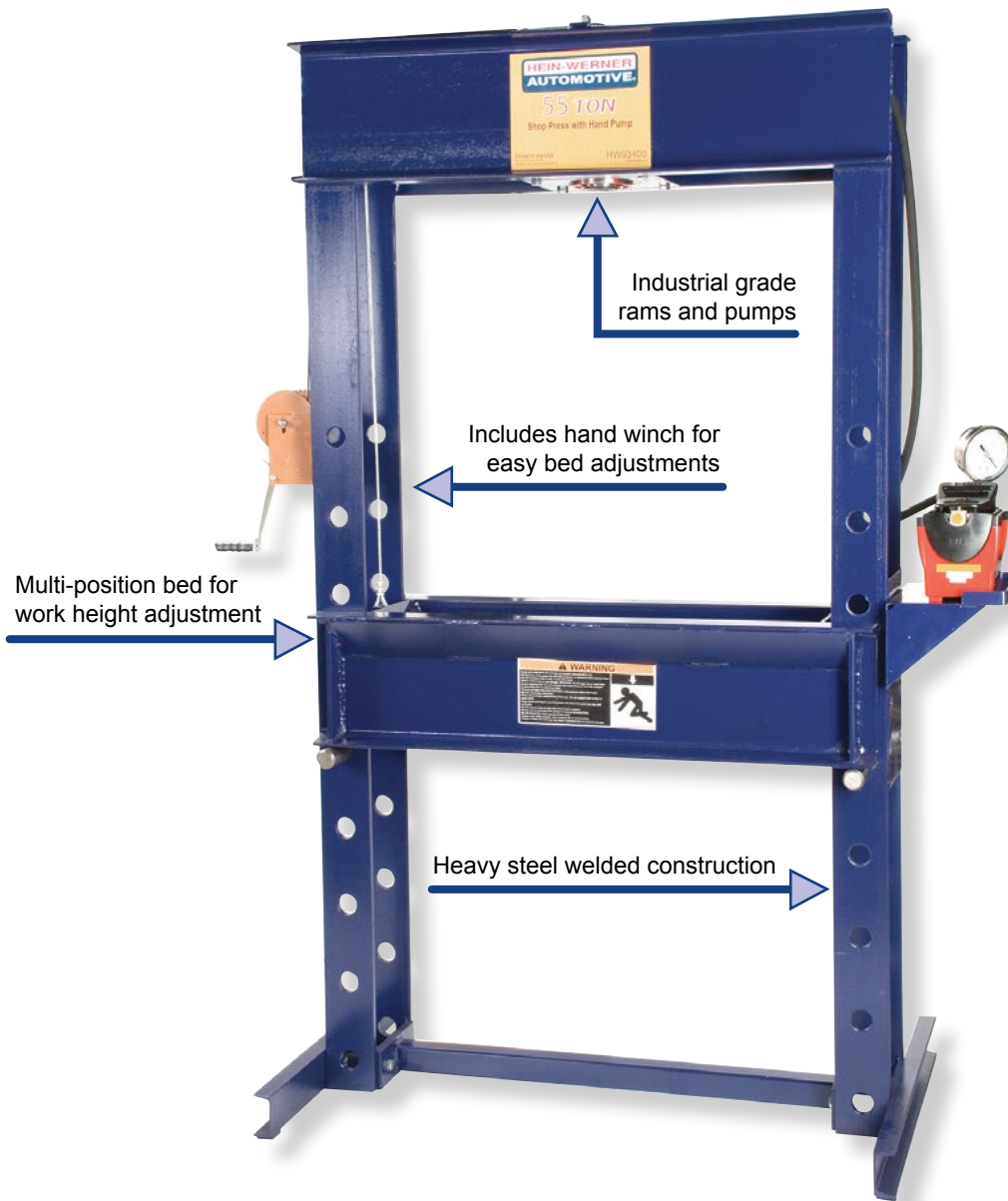

Optional Shop Press Guard HW93425



Model	Capacity	Stroke	Pump Type	Press Size (H x W x L)	Interior Width	Bed Depth	Bed Position	Channel Width	Working Height	G.W.
HW93400	55 Ton	6"	Manual	80-1/2" x 53" x 30"	35-1/2"	14-7/8"	9	9-1/4"	7-1/2" ~ 55-1/2"	855 Lbs.
HW93401			Air							850 Lbs.
HW93402			Electric							916 Lbs.
HW93403		Air	891 Lbs.							
HW93404		Electric	948 Lbs.							
		13"								

HW93410 SERIES - MANUAL, AIR OR ELECTRIC

55 Ton Rolling Head Shop Press

- Frames made in the USA

Made in **USA**

- Excellent for bending, bonding, or straightening applications
- Ideal for the removal or installation of gears, universal joints, pulleys, wrist pins, and other press jobs
- Industrial grade hydraulics

Includes hand winch for easy bed adjustments



Optional Shop Press Guard HW93425

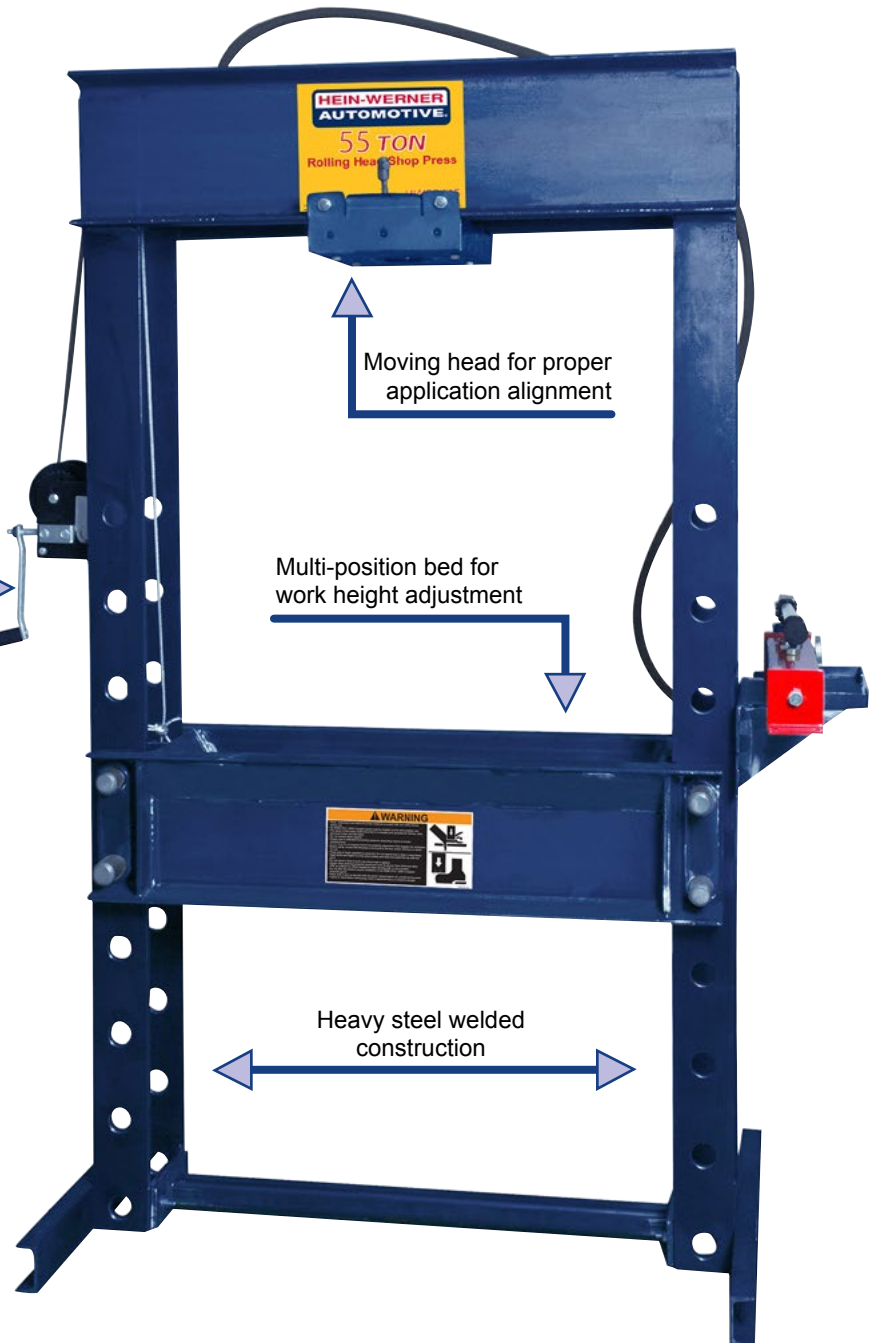

Model	Capacity	Stroke	Pump Type	Press Size (H x W x L)	Interior Width	Bed Depth	Bed Position	Channel Width	Working Height	G.W.
HW93410	55 Ton	6"	Manual	80-1/2" x 53" x 30"	35-1/2"	14-7/8"	9	9-1/4"	15-3/8" ~ 51-3/8"	855 Lbs.
HW93411			Air							850 Lbs.
HW93412			Electric							916 Lbs.
HW93413		Air	891 Lbs.							
HW93414		Electric	948 Lbs.							
HW93415 (Double Acting)		Electric	948 Lbs.							

HW93405 DOUBLE ACTING 55 Ton Shop Press

Double acting cylinder provides fast and efficient advance and retract to minimize time on the job

4" pressure gauge standard

- Frames made in the USA

Made in USA

- Excellent for bending, bonding, or straightening applications
- Ideal for the removal or installation of gears, universal joints, pulleys, wrist pins, and other press jobs
- Industrial grade hydraulics

Industrial grade rams and pumps

Includes hand winch for easy bed adjustments

Multi-position bed for work height adjustment

Heavy steel welded construction

Optional Shop Press Guard HW93425



Model	Capacity	Stroke	Pump Type	Press Size (H x W x L)	Interior Width	Bed Depth	Bed Position	Channel Width	Working Height	G.W.
HW93405	55 Ton	13"	Electric	80-1/2" x 53" x 30"	35-1/2"	14-7/8"	9	9-1/4"	7-1/2"~55-1/2"	968 Lbs.

HW93610 Series 100 Ton Shop Press

• Frames made in the USA

Made in **USA**

• Excellent for bending, bonding, or straightening applications

• Ideal for the removal or installation of gears, universal joints, pulleys, wrist pins, and other press jobs

Includes hand winch for easy bed adjustments

Multi-position bed for work height adjustment

4" pressure gauge standard

Optional Shop Press Guard HW93625



Heavy steel welded construction

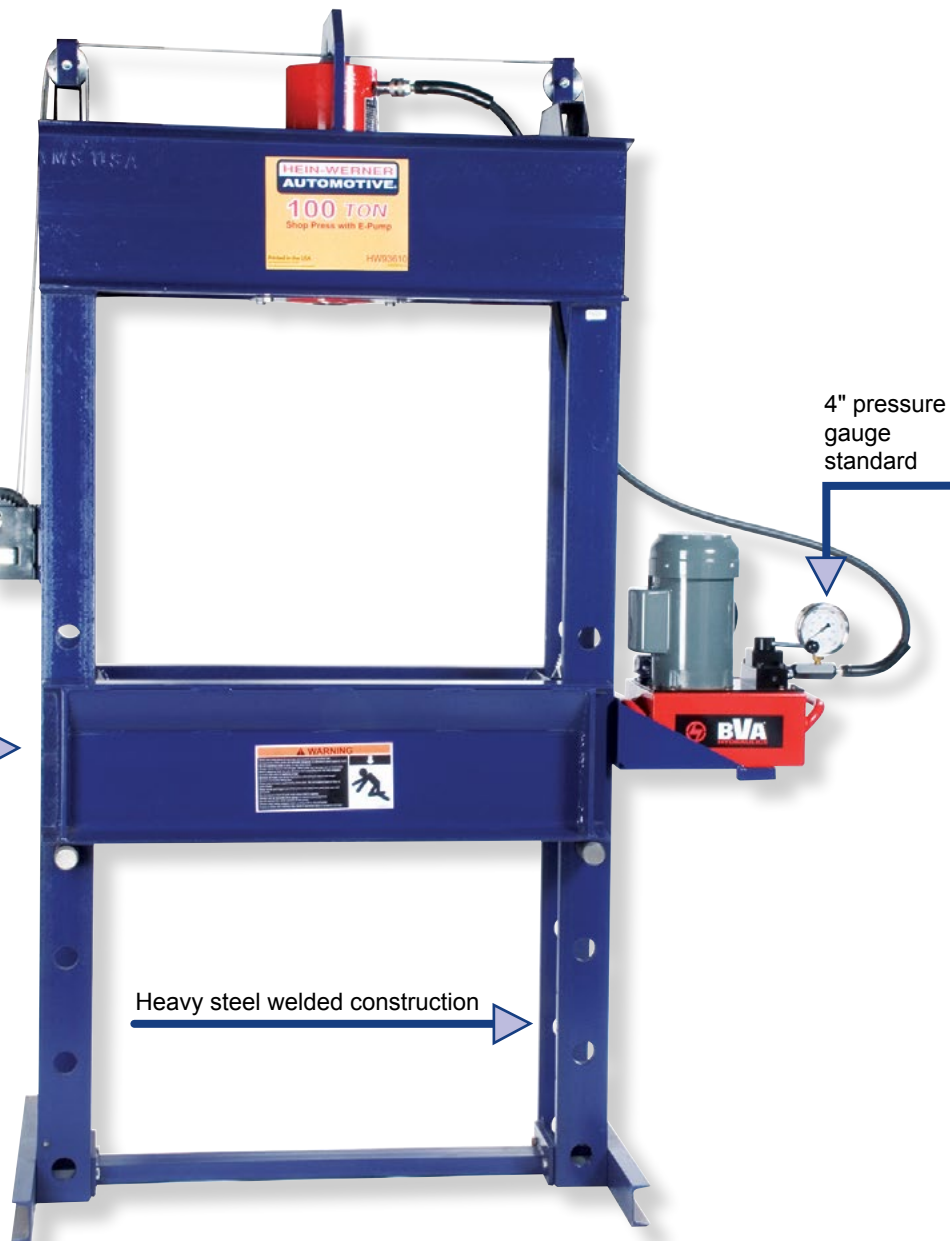

Model	Capacity	Stroke	Pump Type	Press Size (H x W x L)	Interior Width	Bed Depth	Bed Position	Channel Width	Working Height	G.W.
HW93610	100 Ton	10"	Electric	89" x 63" x 30"	35-3/8"	16-1/4"	6	10-1/4	12" ~ 52"	1,221 Lbs.
HW93615							6	10		770 Lbs.

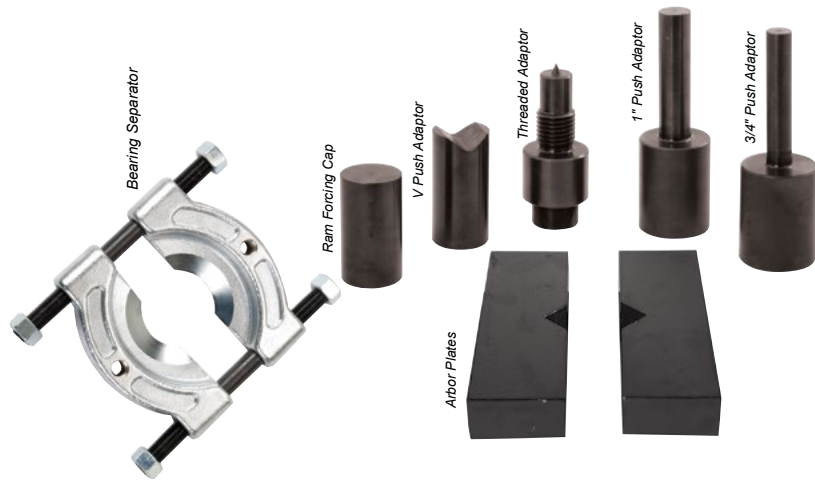

HW93309 25 Ton Shop Press Accessories Kit

Made in USA

Accessories kit contains

- Ram forcing cap (300-002-229)
- V push adaptor (300-002-807)
- Threaded adaptor (300-002-953)
- 1" push adaptor (300-002-511)
- 3/4" push adaptor (300-002-510)
- Arbor plates (AP25)
- Bearing Separators
- G.W. 38 Lbs..



HW93409 55 Ton Shop Press Accessories Kit

Made in USA

Accessories kit contains

- Ram forcing cap (400-002-230)
- V Push adaptor (400-002-808)
- Threaded adaptor (400-002-368)
- 1-1/2" push adaptor (400-002-757)
- 1-1/4" push adaptor (400-002-756)
- Arbor plates (AP55)
- Bearing Separators
- G.W. 79 Lbs..



HW93291 1 Quart Premium Jack Oil

HW93294 1 Gallon Premium Jack Oil

Model Number	Volume	Viscosity Index	Viscosity @ 100°F (S.U.S.)	Viscosity @ 210°F (S.U.S.)	ISO Grade	Flash Point	Pour Point	API Gravity
HW93291	1 Quart	93 min.	65	35	10	405 °F	-59 °F	25.5
HW93294	1 Gallon							

RCHW100

Hein-Werner Racing Chair





TWO YEAR LIMITED WARRANTY

Warranty Information

For a period of two (2) years from date of purchase, SFA Companies will repair or replace, at its option, without charge, any of its products which fails due to a defect in material or workmanship under normal usage. This limited warranty is a consumer's exclusive remedy.

Performance of any obligation under this warranty may be obtained by returning the warranted product, freight prepaid, to:

SFA Companies Warranty Service Department, 10939 N. Pomona Ave., Kansas City, MO 64153.

Except where such limitations and exclusions are specifically prohibited by applicable law:

(1) THE CONSUMER'S SOLE AND EXCLUSIVE REMEDY SHALL BE THE REPAIR OR REPLACEMENT OF DEFECTIVE PRODUCTS AS DESCRIBED ABOVE.

(2) SFA COMPANIES SHALL NOT BE LIABLE FOR ANY CONSEQUENTIAL OR INCIDENTAL DAMAGE OR LOSS WHATSOEVER.

(3) ANY IMPLIED WARRANTIES, INCLUDING WITHOUT LIMITATION THE IMPLIED WARRANTIES OF MERCHANTABILITY AND FITNESS FOR A PARTICULAR PURPOSE, SHALL BE LIMITED TO TWO YEARS, OTHERWISE THE REPAIR, REPLACEMENT OR REFUND AS PROVIDED UNDER THIS EXPRESS LIMITED WARRANTY IS THE EXCLUSIVE REMEDY OF THE CONSUMER, AND IS PROVIDED IN LIEU OF ALL OTHER WARRANTIES, EXPRESS OR IMPLIED.

(4) ANY MODIFICATION, ALTERATION, ABUSE, UNAUTHORIZED SERVICE OR ORNAMENTAL DESIGN VOIDS THIS WARRANTY AND IS NOT COVERED BY THIS WARRANTY.

- Some states do not allow limitations on how long an implied warranty lasts, so above limitation may not apply to you.
- Some states do not allow the exclusion or limitation of incidental or consequential damages, so the above limitation or exclusion may not apply to you. The warranty gives you specific legal rights, and you may also have other rights which vary from state to state.



Global Locations



USA

Shinn Fu Company of America
10939 N. Pomona Ave
Kansas City, MO 64153
USA

Tel: 888-332-6419, 816-891-6390
Fax: 816-891-6599
Email: sales@omegalift.com

Canada

Shinn Fu Company of Canada, Inc.
6355 Shawson Drive, Unit 1
Mississauga, Ontario L5T 1S7
Canada

Tel: 888-820-3737, 1-905-362-2277
Fax: 905-362-2280
Email: sales@shinnfucanada.ca

Asia

Shinn Fu Corporation Headquarters
7F., NO.618 Ruei Guang Road
Nei Hu District, Taipei City 114
Taiwan R.O.C.

Tel: 886-2-87517888
Fax: 886-2-87517999

Europe

Shinn Fu Europe B.V.
Tussenrimer 20, 4704 SR
Roosendaal
The Netherlands

Tel: +31-165-583-300
Fax: +31-165-583-310
Email: sales@sfeu.nl

Australia

Shinn Fu Australia PTY, Ltd.
15 Viewtech Place
Rowville 3178 Victoria
Australia

Tel: +61-3-9755-8277
Fax: +61-3-9755-8219

